

Thank you for your purchase of this Citizen watch.

Before using the watch, read this instruction manual carefully to ensure correct use.

After reading the manual, store it in a safe place for future reference.

Be sure to visit the Citizen website at <http://www.citizenwatch-global.com/>. Here you will find a variety of information such as electronic setting guides, answers to frequently asked questions, Eco-Drive recharging information and more.

English

#### To check the movement number

A case number—4 alphanumeric characters and 6 or more alphanumeric characters—is engraved on the case back. (Figure on the right)

The first 4 characters of the case number represent the movement number of the watch.

In the example on the right, “△△△△” is the movement number.

#### Engraving position example

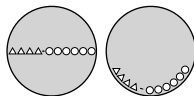



The engraving position may differ depending on watch model.



## Safety precautions — IMPORTANT

This manual contains instructions that should be strictly followed at all times not only for optimal use, but to prevent any injuries to yourself, other persons or property. We encourage you to read the entire booklet (especially, pages **84** to **96**) and understand the meaning of the following symbols:

- Safety advisories are categorized and depicted in this manual as follows:

 <b>DANGER</b>	Highly likely to cause death or serious injury
 <b>WARNING</b>	Can cause serious injury or death
 <b>CAUTION</b>	Can or will cause minor or moderate injury or damage

- Important instructions are categorized and depicted in this manual as follows:

	Warning (caution) symbol followed by instructions that should be followed or precautions that should be observed.
	Warning (caution) symbol followed by prohibited matters.

## Before using this watch

After unpacking, the following must be done before using the watch:

- **Checking the power reserve** → see page **16**  
For optimal performance, ensure your watch is fully charged prior to use. Refer to pages **10** to **15** for charging procedures and times.
- **Setting the correct time and date for your locale**  
The time may be adjusted either manually (see pages **62** to **67**), or by receiving time information when connected with iPhone, a mobile digital device, using the app available from the App Store (see page **47**).

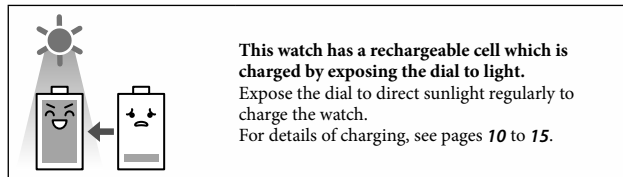

**This watch has a rechargeable cell which is charged by exposing the dial to light.**  
Expose the dial to direct sunlight regularly to charge the watch.  
For details of charging, see pages **10** to **15**.

### Band adjustment

We do not recommend attempting to adjust the watch band yourself. Special expertise and experience is required for proper adjustment. If not adjusted correctly, the band may become detached leading to an injury or loss of your watch. (Some retailers may supply a band adjustment tool with your purchase).

For band adjustment, we recommend you consult the retailer where the watch was purchased or your nearest Authorized Citizen Service Center.

Some repair shops may charge a nominal fee for adjustment if the watch was not purchased directly from them.

### Protective stickers





Be sure to remove any protective stickers that may be on your watch (case back, band, clasp, etc.). Otherwise, perspiration or moisture may enter the gaps between the protective stickers and the parts, which may result in a skin rash and/or corrosion of the metal parts.

### How to use a specially designed crown/push button

Some models are equipped with a specially designed crown and/or push button(s) to prevent accidental operation. Please refer to the following chart for use.

### Screw down crown and screw down push button

Unlock the crown prior to operate your watch.

	Unlock	Lock
<b>Screw down crown</b>	 <p>Rotate the crown counterclockwise until it releases from the case.</p>	 <p>Push the crown in to the case. With gentle pressure towards the case, rotate the crown clockwise to secure it to the case. Be sure to tighten firmly.</p>
<b>Screw down push button</b>	 <p>Rotate the locking screw counterclockwise, and loosen until it stops.</p>	 <p>Rotate the locking screw clockwise, and tighten firmly.</p>

### Recessed buttons

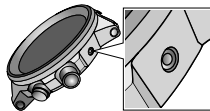

Press the button with a narrow-tipped object such as a wooden toothpick.

## Table of contents

Features .....	8	Disconnecting with iPhone [DCT] .....	41	Bluetooth 4.0 wireless technology .....	59	Resetting the watch — All Reset .....	81
Component identification .....	9	Connecting to the registered iPhone [CT] .....	44	Adjusting the time and calendar manually [TME]/[CAL] ....	62	Eco-Drive (solar powered) watch handling precautions.....	84
Charging your watch .....	10	Activating the functions of the dedicated app .....	46	Using local time [L-TM] .....	68	Water resistance .....	88
Checking the current power reserve.....	16	Receiving email reception notification [Email Alert] ....	52	Using the chronograph [CHR].....	70	Precautionary items and usage limitations .....	91
Changing the mode.....	18	Shortcut for registration (pairing).....	58	Checking and correcting the reference position [▶0◀] ....	72	Information .....	97
Before connecting to iPhone ..	24			Troubleshooting .....	76	Specifications.....	98
Registering (Pairing) your iPhone [PR].....	35						

## Features



Connectable with your iPhone using Bluetooth 4.0 through the dedicated app, and equipped with the following features:

- Automatic Time Sync on page 47
- iPhone Search on page 51
- Incoming Call Alert on page 48
- Email Alert on page 52
- Link Loss Alert on page 50
- Schedule Alert on page 49

**Eco-Drive (solar powered):** Never needs a new battery. This watch is fueled by light.

**Chronograph:** Measure elapsed time up to 60 minutes.

**Local time:** Easy to see the time for a second time zone, anywhere in the world.

**Perpetual calendar:** Once set, the date will automatically adjust for months shorter than 31 days as well as leap years.

\* “Eco-Drive” is Citizen’s proprietary technology.

## Component identification

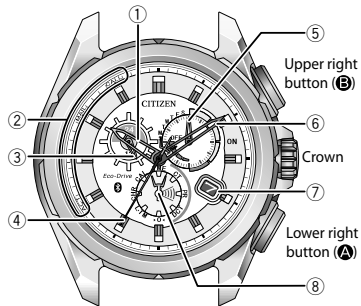

The illustrations in this instruction manual may differ from the actual appearance of your watch.

- ① Hour hand
- ② Notification indication for connecting to iPhone (see pages 32)
- ③ 24-hour hand on the upper left sub dial
- ④ Second hand/Chronograph second hand
- ⑤ Function hand and function indications on the upper right sub dial
  - Connection status (see page 32)/ Power reserve level (see pages 16 and 17)
  - Chronograph minute hand
  - Day of the week
- ⑥ Minute hand
- ⑦ Date indication
- ⑧ Mode hand on the lower sub dial (see pages 18 to 23)

## Charging your watch

This watch has a rechargeable cell which is charged by exposing the dial to light, such as direct sunlight or fluorescent lamps (refer to pages 12 and 13 for charging guidelines).

After taking off the watch, put it in a location where the dial is exposed to bright light, such as by a window.

For optimal performance, be sure to:

- Expose the watch to direct sunlight half a day at least once a week.
- Avoid leaving the watch in dark places for long periods of time.

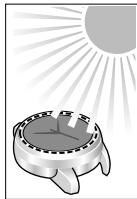

### Caution

- Do not charge the watch at high temperature (about 60°C/140°F or higher).
- If the watch is obscured from light by long sleeves frequently, supplemental charging may be needed to ensure continual operation. Refer to pages 12 and 13.

## When the watch reaches a low charge state (insufficient charge warning function)

When the power reserve becomes low, the second hand moves once every two seconds. This is the insufficient charge warning function. Be sure to fully charge your watch as outlined on pages 12 and 13.

- When the watch is sufficiently charged, the second hand will move normally.
- If you do not charge the watch for 10 days or longer after the insufficient charge warning movement has begun, the watch will be depleted of all power and stop.

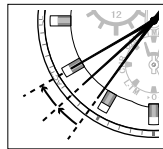

### Caution

- When in the insufficient charge warning state, the current time and date are indicated. However, other features and functions of the watch will not be available for use.

## Charging time by environment

Below are the approximate times required for charging when exposing the watch dial to light continuously. Please use this table as a reference only.\*

Environment	Illuminance (lx)	Charging time (approx.)		
		To work for one day	To start working normally when the cell is discharged	To become fully charged when the cell is discharged
Outdoors (sunny)	100,000	12 minutes	3.5 hours	13 hours
Outdoors (cloudy)	10,000	30 minutes	6.5 hours	30 hours
20 cm (7-7/8 inches) away from a fluorescent lamp (30W)	3,000	1.5 hours	15 hours	90 hours
Interior lighting	500	8 hours	80 hours	600 hours

- To charge your watch, it is recommended to expose the dial to direct sunlight. Optimal charging is achieved by exposing the dial to direct sunlight outdoors for a short time each day.

### Power reserve in normal use from fully charged without additional charging

With connecting to iPhone	Without connecting to iPhone
About 8 months*	About 17 months

- \* When the watch is connected to your iPhone about 6 hours a day and received messages about 10 times a day, you can use the connecting feature between the watch and your iPhone about 30 days in 8 months. For details, see page 17.

### Caution when connecting to iPhone

- Connecting to iPhone requires a substantial amount of power, especially if receiving many notifications. Be sure to keep your watch fully charged when utilizing this feature.
- We recommend disconnecting with iPhone when not needed (see page 41).
- Connecting feature does affect battery usage on your iPhone. Be sure to check the charge level of your iPhone.

## Power save function

If your watch is not exposed to light sufficient for charging for 30 minutes or more, the second hand will stop in order to conserve power. Although the second hand is not moving, the correct seconds are stored in memory.

The power save function cannot be activated manually; it is an automatic feature only. The power save function does not operate under the following conditions:

- The crown is in position **1** or **2**.
- The current mode is Chronograph [**CHR**] or Calendar [**CAL**].
- The second hand is indicating a notification (“**MAIL**”/ “**CALL**”/ “**LL**”).

## Canceling the power save function

The power save function is automatically canceled when the watch is exposed to light sufficient for charging. The second hand will then resume normal movement.

- The power save function will also be canceled if a notification is received from your iPhone. Note: the watch must be sufficiently charged and the dedicated app running on your iPhone in order to receive notifications.
- If the watch is in the power save state for long period of time, adjust the time and date before use through the iPhone connection (see page **47**) or manually (see page **62**).



## Checking the current power reserve

This watch has a power reserve display feature when in [TME], [L-TM], [PR], [CT], or [DCT] mode.

### Power reserve indication (Function hand on the upper right sub dial)

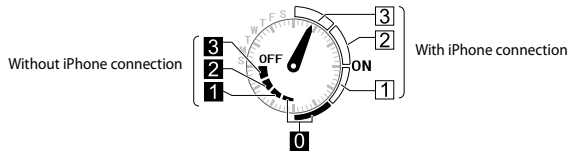

- If the current power reserve is not displayed (the watch is in [CAL] or [CHR] mode), change the mode (see page 18).
- When connecting to iPhone, pay particular attention to the power reserve to ensure sufficient power is available.

## Checking the current power reserve

### The power reserve level

Level	3	2	1	0
Approximate duration of indication at this level	With connecting to iPhone within 6 hours a day			7 months*
	Up to 10 days	Up to 15 days	Up to 5 days	
	Without connecting to iPhone			
	Up to 3 months	Up to 5 months	Up to 2 months	
	Power reserve is sufficient for all features and functions. Optimal performance is achieved at this level.	Power reserve is sufficient for all operations at this level.	Power reserve is getting low. The watch should be fully charged to ensure optimal performance.	Power reserve is not sufficient for normal operation. The watch must be fully charged.
			<b>Charge the watch immediately.</b>	

\* When the power reserve is at level "0", basic watch functions can be used. However, registering (see pages 35 to 40) and connecting to iPhone (see pages 44 and 45) are not available. If the watch is connected to your iPhone and the power reserve becomes at level "0", the connection will be disconnected automatically.

## Changing the mode

This watch features eight different modes (functions). Change the mode by rotating the mode hand on the lower sub dial before using each mode.

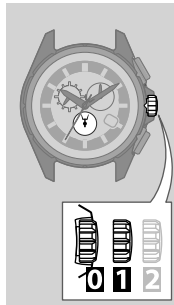

### 1 Pull the crown out to position 1.

The second hand moves to indicate the 30 seconds position.

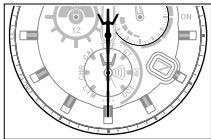

The second hand indicates the 30 seconds position.

### 2 Rotate the crown to select a mode.

- Each time you rotate the crown, the mode hand on the lower sub dial moves. Rotate the crown until the mode hand indicates the mode you wish to use.

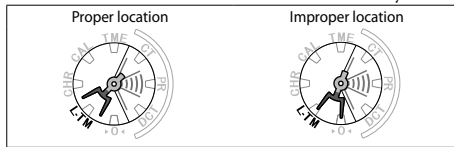

Ex. When selecting [L-TM]

- You may turn the mode hand either clockwise or counterclockwise.
- The hands/indications function differently in each mode. See pages 20 to 23 for more details of each mode and the functions of the hands/indications in each mode.

### 3 Push the crown in to position 0 to finish the procedure.

### Mode indications and functions

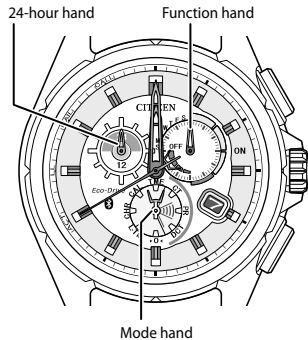

#### Time — [TME]

- Normally, use the watch in [TME] or [L-TM] mode.

[TME]
<p>The currently set time is displayed.</p> <ul style="list-style-type: none"> <li>• The function hand on the upper right sub dial indicates the power reserve in this mode.</li> </ul>

### Pairing/Connecting/Disconnecting of iPhone — [PR]/[CT]/[DCT]

[PR] (Pairing)	[CT] (Connect)	[DCT] (Disconnect)
<p>Select this when you want to connect (pair/register) the watch to your iPhone for the first time. (See page 35.)</p>	<p>Select this mode when you want to connect your watch to your iPhone after initial pairing. (See page 44.)</p>	<p>Select this when you disconnect the watch from your iPhone. (See page 41.)</p>

- Time indication is same as either [TME] or [L-TM].

## Local time — [L-TM]

**[L-TM]**



Select this to display the time of another area (local time). (See page 68.)

- The 24-hour hand on the upper left sub dial, date and day of the week display local time.
- The function hand on the upper right sub dial indicates the power reserve in this mode.

## Chronograph — [CHR]

**[CHR]**



Select this when you want to use the chronograph. (See page 70.)

- **The second hand:** Indicates the chronograph seconds.
- **The function hand on the upper right sub dial:** Indicates the chronograph minutes.
- The hour, minute and 24-hour hands will continue to reflect the time set in [TME] or [L-TM] mode.

## Calendar — [CAL]

**[CAL]**



Select this to display the calendar. (See page 64.)

- **The second hand:** Indicates the year/month.
- **The function hand on the upper right sub dial:** Indicates the day of the week.
- The hour, minute and 24-hour hands will continue to reflect the current time set in [TME] mode.

## The reference position — [▶0◀]

**[▶0◀]**



The current reference position of each hand/indication is indicated. (See page 72.)

## Before connecting to iPhone

This watch communicates with iPhone through the connection of Bluetooth 4.0, which is featured Bluetooth Low Energy (BLE) power-saving technology. It is required for connection to install and start up a dedicated app “**CITIZEN ECO-DRIVE Proximity**” on a compatible iPhone. The flow for connection is shown as follows.

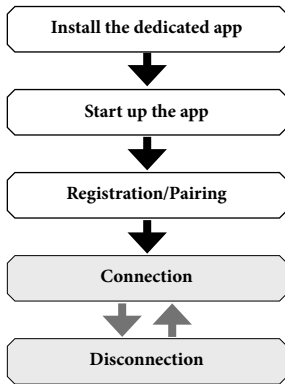

## iPhone connectable with this watch

To check the latest information on compatible iPhone and iOS, visit the following sites:

- Citizen Watch global site: “<http://www.citizenwatch-global.com/>” → “**Service & Support**” → “**W760**” in “**User’s Site**”
- App Store: The install page of the app “**CITIZEN ECO-DRIVE Proximity**”

Set the mode to [DCT] (see page 42) to use this watch as a standard one in places such as an airplane, where electronic devices are limited to use.

iPhone is a trademark of Apple Inc., registered in the U.S. and other countries. The Bluetooth® word mark and logos are registered trademarks owned by Bluetooth SIG, Inc.

## Functions available with the connection

### Automatic adjustment of time and calendar [Time Sync]

The watch adjusts time and calendar automatically using time info provided from the iPhone.

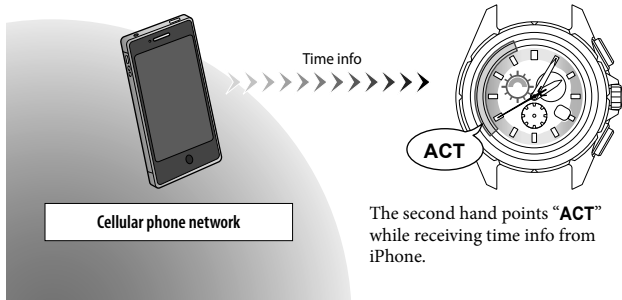

### Incoming call notification [Incoming Call]

Incoming call alert comes to the watch since iPhone's call reception.

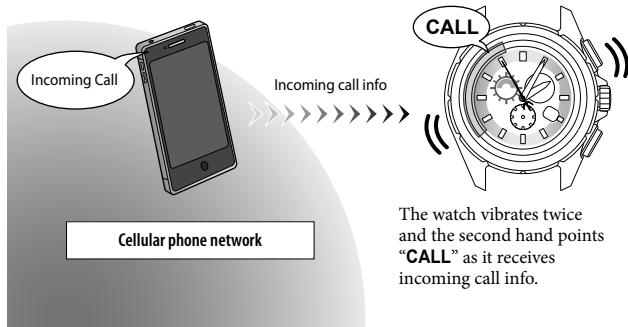

### Schedule notification [Schedule Alert]

The watch receives schedule notification from the built-in Calendar app on your iPhone, corresponding to the setting of the app.

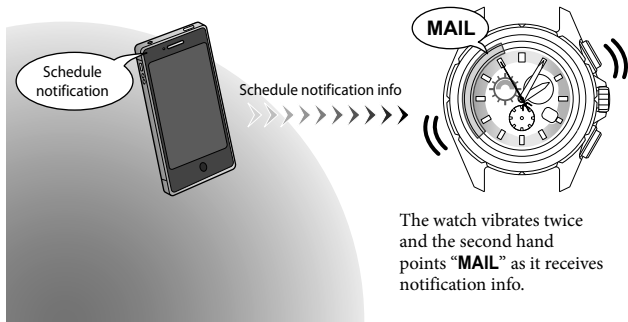

### Email reception notification [Email Alert]

Email alert comes to the watch since iPhone's email reception to the account set on the dedicated app.

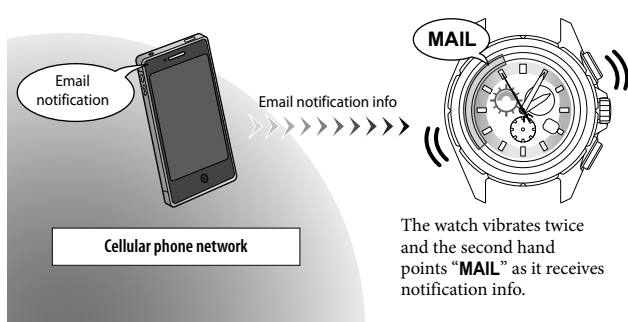

Link Loss alert (Bluetooth disconnection notification) [Bluetooth Link Loss Alert]

The watch notifies iPhone's disconnection due to their distance.

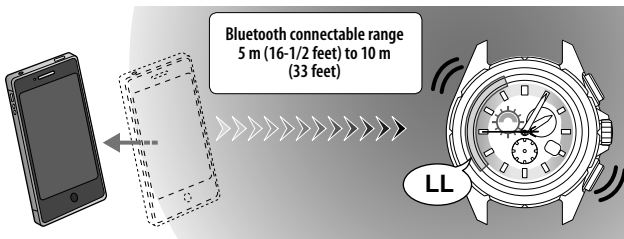

The watch vibrates twice and the second hand points "LL" as it detects disconnection.

iPhone search [iPhone Search]

The watch sends signals to the registered iPhone within the connectable range.

- This function is also available when they are disconnected.

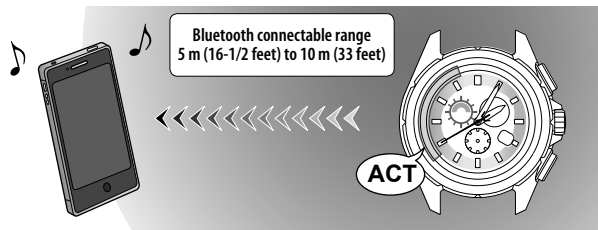

The iPhone sounds (depending on the setting) as it receives the signal.

The second hand points "ACT" as it starts to send signals.



## Connection and notification indication on the watch

- Because the watch vibrates gently for the notification, it is recommended to check the vibration in advance. (See page 34.)

### Notification position of the second hand

<b>CALL</b>	Incoming phone calls
<b>MAIL</b>	Emails and schedule info
<b>LL</b>	Disconnection (Link Loss)
<b>ACT</b>	The watch is waiting to be connected or processing communication (Activation)

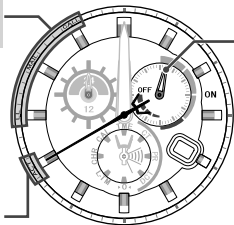

### Connection status (the function hand on the upper right sub dial)

<b>ON</b>	Connected
<b>OFF</b>	Not connected.

- Since the actual pointing position of the hand varies depending on the amount of charge, distinguish "ON" and "OFF" by the area the hand points.

- The maximum connectable range is about 10 m (33 feet). Connectable range may be shorter due to obstacles such as walls.  
Do not block the watch with your body such as your arm.
- When [▶0◀], [CHR] or [CAL] mode is selected, only vibration gives you notification. The indication by the second hand will be made with another vibration when you change the mode to [TME], [L-TM], [PR] or [CT].  
You can check how the watch vibrates in advance. (See page 34.)
- When the watch receives a new info while the second hand indicates a notification type, the hand's indication is updated corresponding to the new info.

### Stopping the notification indication

Press and hold either the lower right button **A** or upper right button **B** for two seconds while the second hand indicates a notification, and the second hand stops the notification indication and return to the normal movement.

## Testing the vibration of the watch

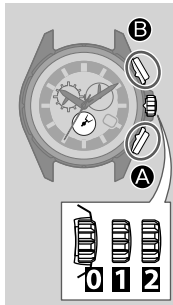

- 1 Change the mode to [CT].** (See pages 18 and 19)
- 2 Pull the crown out to position 2.**
- 3 Press and release either the lower right button A or upper right button B.**

The watch starts vibrating.

  - The vibration is different from the actual notification vibration.
- 4 Push the crown in to position 0.**
- 5 Change the mode to either [TME] (or [L-TM]) to finish the procedure.** (See pages 18 and 19)

## Registering (Pairing) your iPhone

[PR]

When connecting the watch and your iPhone for the first time, mutual registration (pairing) is required.

### Before registration

- For registration, you have to operate both the watch and the iPhone.
- Be sure that the watch and the iPhone are charged enough. Especially, check the power reserve indication of the watch (see page 16) and charge it before registration if the power reserve level is “1” or “0”.
- The watch and the iPhone is connected after registration.

**Connection after registration**

Once the registration has been completed, re-registration (pairing) is not required except for the cases below. Execute reconnection (see page 44) when disconnected.

- After registering with another iPhone
- After uninstalling the dedicated app from the iPhone
- After restoring iPhone to the factory setting

**Registering the iPhone**

The iPhone registration on the watch must be completed within about 2 minutes. If about 2 minutes have passed before finishing the registration, the watch returns to the normal movement.

- The installed app is shown as the icon.
- After registration, set the functions to “ON” on the app’s screen on the iPhone. (See page 46)



App icon



<Operation on iPhone>

- 1 Download and install the dedicated app “CITIZEN ECO-DRIVE Proximity” from App Store.**
- 2 Tap the app icon to start up the app.**
- 3 Slide the switch of “Scan” to “ON” on the app’s screen.**



The iPhone starts to detect the watch.

- Do not change the app screen until the registration is completed.
- When “**Waiting for Reconnection**” is shown, slide the switch to “**OFF**”.
- When the iPhone’s Bluetooth setting is “**OFF**”, an activation dialog appears.

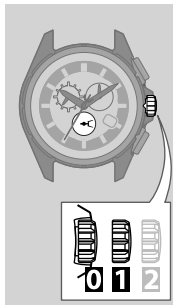

<Operation on the watch>

**4 Pull the crown out to position 1.**

The second hand moves to indicate the 30 seconds position.

**5 Rotate the crown to change the mode to [PR].**

**6 Push the crown in to position 0.**

The second hand moves to indicate the “ACT” position, allowing the watch to be detected for two minutes.

- The last register information will delete in this step..

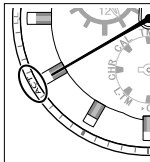

<Operation on iPhone>

**7 Tap “Pair” when the permission request of Bluetooth connection appears on the app’s screen.**

Registration completes successfully when “Proximity Connect” appears on the screen.

Proximity Connect

ON

- It may take up to 20 to 30 seconds to complete the registration.

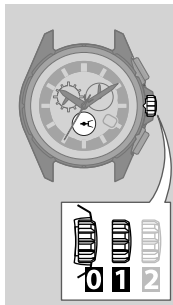

<Operation on the watch>

The function hand on the upper right sub dial points the area shown on the left (“ON” area) when registration completes successfully and the watch is connected with the iPhone.

“ACT” indication ends and the second hand returns to second indication.



**8 Change the mode to either [TME] (or [L-TM]) to finish the procedure.** (See pages 18 and 19)

**Disconnecting with iPhone**

[DCT]

You can close the connection with the iPhone in the following cases:

- When the function hand on the upper right sub dial indicates “ON” area.
- When the watch mode is set to [TME], [L-TM], [PR] or [CT].
- When the second hand indicates the second.

(While the second hand indicates a notification type, stop the notification indication by pressing and holding either the lower right button **A** or upper right button **B** for two seconds.)

**1 Press and hold the upper right button **B** for seven seconds or more.**

The connection is closed and the function hand on the upper right sub dial points the “OFF” area.

- To close connection from the iPhone, slide the switch of “Proximity Connect” to “OFF”. The switch name changes to “Scan”.



Function hand on the upper right sub dial

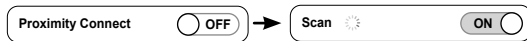

Continued on the next page

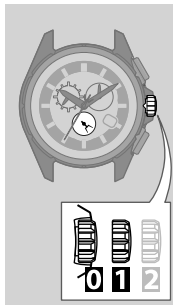

You can also close connection by changing the mode of the watch.

**1 Change the mode to [DCT].** (See pages 18 and 19)

The connection is closed and the function hand on the upper right sub dial indicates “OFF” area.

- In this case, the switch name changes from “Proximity Connect” to “Waiting for Reconnection”.



Function hand on the upper right sub dial

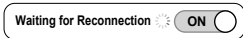

**2 Change the mode to either [TME] (or [L-TM]) to finish the procedure.** (See pages 18 and 19)

**Checking the connection status on the app screen**

While connected	Proximity Connect <input checked="" type="checkbox"/>	You can use the functions with the setting “ON”.
Disconnected	Waiting for Reconnection <input checked="" type="checkbox"/>	Only the following operations are available: <ul style="list-style-type: none"> <li>• Reconnection with the operation on the watch (see page 44)</li> <li>• Searching for your iPhone (see page 51)</li> </ul>
	Scan <input checked="" type="checkbox"/>	It is recommended to stop or quit the app to save the batteries of the watch and/or the iPhone when leaving them disconnected for a long time.
App in rest	Scan <input type="checkbox"/>	<ul style="list-style-type: none"> <li>• The Bluetooth setting on the iPhone remains “ON” even when “Scan” is set to “OFF” or the app is not active.</li> </ul> The app does not consume the iPhone battery.

## Connecting to the registered iPhone

[CT]

You can reconnect with the registered iPhone again in the following cases:

- When the function hand on the upper right sub dial indicates “OFF” area.
- When the watch mode is set to [TME], [L-TM], [PR] or [CT].
- When the second hand indicates the second.

(While the second hand indicates a notification type, stop the notification indication by pressing and holding either the lower right button **A** or upper right button **B** for two seconds.)

### 1 Confirm the switch of “Scan” or “Waiting for Reconnection” is “ON” on the app’s screen.



Function hand on the upper right sub dial

### 2 Press and release the upper right button **B**.

The second hand moves to indicate “ACT”. When successfully connected, the movement of the second hand returns to normal and the function hand on the upper right sub dial indicates “ON” area.

- It may take up 20 to 30 seconds to complete the reconnection.

## Connecting to the registered iPhone [CT]

You can also reconnect the watch and the iPhone by changing the mode of the watch.

### 1 Change the mode to [CT]. (See pages 18 and 19)

The second hand moves to indicate “ACT”. When successfully connected, the movement of the second hand returns to normal and the function hand on the upper right sub dial indicates “ON” area.

- It may take up 20 to 30 seconds to complete the reconnection.



Function hand on the upper right sub dial

### 2 Change the mode to either [TME] (or [L-TM]) to finish the procedure. (See pages 18 and 19)

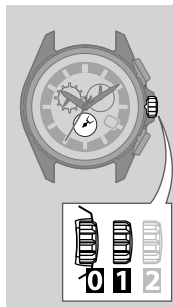

## Activating the functions of the dedicated app

You can set functions to “ON” or “OFF” on the app’s screen during connection. For the details of each function, refer to the pages shown below.

Function	Page	Description
Time Sync	47	Sends time/calendar info.
Incoming Call	48	Sends notification of incoming call.
Schedule Alert	49	Sends notification of schedule from the built-in Calendar app on the iPhone.
Email Alert	52	Sends notification of email reception for the account registered to the app.
Bluetooth Link Loss Alert	50	Notifies when the connection is interrupted.
iPhone Search	51	Makes the iPhone sounding to answer the signal from the watch.

### Automatic adjustment of time and calendar [Time sync]

When you set “Time Sync” to “ON”, the watch receives the time info (year, month, date, day, hour, minute, second) from the iPhone and adjust the time following it each time they are connected.



- The time on the watch is adjusted automatically each time they are connected and the time setting of your iPhone is changed during connection.
- The local time (see pages 68 and 69) is also adjusted based on the time difference set as the time is adjusted.
- If the watch cannot receive the time information from the iPhone, a message will appear on the iPhone.
- This watch keeps  $\pm 15$ -second monthly accuracy even if no time info is received.

### Receiving the time info manually

You can receive the time info manually by pressing and holding the lower right button A for 2 seconds. Time info reception is executed when the mode is [TME], [L-TM], [PR] or [CT] and the second hand indicate second.



**Receiving incoming call notification [Incoming Call]**

When you set “**Incoming Call**” to “**ON**”, the watch receives incoming call info from the iPhone connected.

**When receiving incoming call info**

The watch vibrates twice and the second hand points “**CALL**”.

- To return the second hand to normal movement, press and hold either the lower right button **A** or upper right button **B** for two seconds.

**Receiving schedule notification [Schedule Alert]**

When you set “**Schedule Alert**” to “**ON**”, the watch receives schedule notification from the iPhone connected.



- For schedule alert setting, set it on the alert setting of the iPhone’s Calendar.

**When receiving schedule notification**

The watch vibrates twice and the second hand points “**Mail**”.

- To return the second hand to normal movement, press and hold either the lower right button **A** or upper right button **B** for two seconds.

## Receiving the leaving-iPhone alert (Bluetooth disconnection notification) [Bluetooth Link Loss Alert]

When you set “**Bluetooth Link Loss Alert**” to “**ON**”, the watch alerts when the communication with the iPhone is closed due to the iPhone location or other unintentional reasons.

Bluetooth Link Loss Alert  ON

- No notification is sent to the watch if the iPhone and other Bluetooth devices are disconnected.

### When the iPhone is disconnected

The watch vibrates twice and the second hand points “**LL**”.

The watch automatically tries to reconnect with the iPhone once (The second hand points “**ACT**”), but close connection if the reconnection failed and the function hand points the “**OFF**” area.

- To return the second hand to normal movement, press and hold either the lower right button **A** or upper right button **B** for two seconds.

## Searching for the iPhone [iPhone Search]

When you set “**iPhone Search**” to “**ON**”, you can send signals to the registered iPhone in the connectable range with the watch.

When receiving the signal, the iPhone sounds depending on its setting.

iPhone Search  ON

### Locating your iPhone using sounds

Press and release both the lower right button **A** and the upper right button **B** simultaneously when the mode of the watch is [TME], [L-TM], [PR] or [CT] and the second hand indicate second.

The second hand points “**ACT**” and the signals are started to send.

- It may take up 20 to 30 seconds to start sounding.
- When the switch of “**Scan**” or “**Waiting for Reconnection**” is “**ON**”, the signals can be sent to the disconnected iPhone.
- iPhone sounds even when the muting switch is activated or the sound volume is set to 0.
- When the earphones are plugged, iPhone does not sound.

## Receiving email reception notification [Email Alert]

When you set “**Email Alert**” to “**ON**”, the watch receives email notification at email arrival to the account set on the dedicated app “**CITIZEN ECO-DRIVE Proximity**”.



- You can enter up to five mail accounts.
- This function does not notify the receptions of iPhone's Mail and SMS.
- This app only check existence of new unread mails on mail servers. You cannot browse mails on it.

### When receiving email reception notification

The watch vibrates twice and the second hand points “**MAIL**”.

- To return the second hand to normal movement, press and hold either the lower right button **A** or upper right button **B** for two seconds.

## Receiving email reception notification [Email Alert]

### Setting the mail account

To send the mail reception info to the watch, you have to set mail accounts on the dedicated app.

- This function is only available for accounts whose mail servers are compatible with IMAP.
- Prepare IMAP mail account, IMAP mail server addresses for sending and receiving, user name and password before setting. Consult your mail service provider for the information required.
- You can set the mail accounts before connection.

### 1 Tap the app icon to start up the app and tap “Mail Accounts”.



**2 Tap “+” to add an account.**

- Tap an existing account to edit its setting.

**3 Select an IMAP mail service you use on the list and tap its name.**

- If your mail service is not listed, tap “Other”.

**4 Enter items required and tap “Done”.**

Connection test to the mail server starts immediately and the mail account entered is verified. When the test ends successfully, the screen of step 2 appears again.

- When the test fails, a failure message appears. Enter items required again.

**5 Repeat steps 2 to 4 to set other accounts.**

- The accounts set are listed under “Email Alert”.

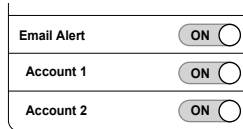
**6 Tap “Back” to finish the setting.****To delete an existing mail account from the app**

Tap “Delete Account” on the screen of an existing account.

- All the settings are deleted as the dedicate app is uninstalled on the iPhone.

**Selecting accounts for which mail reception notification is sent**

You can select accounts for mail reception notification by setting them to “ON” or “OFF”.

**1 Tap the app icon to start up the app.**

**2 Slide the switch for each account under “Email Alert” to “ON” or “OFF”.**

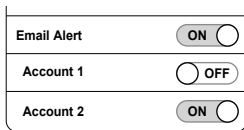
**Adjusting the interval of mail reception notification**

You can adjust the interval of mail reception notification.

- The interval set is common to all mail accounts.

**1 Tap the app icon to start up the app and tap “Mail Accounts”.**

**2 Tap “Polling Interval”.**

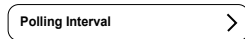

**3 Tap the interval you prefer.**

The larger the Mail check interval is, the larger the power consumption is. It is recommended to set a larger interval if possible.

**4 Tap “Mail Settings” → “Back” to finish the setting.**

## Shortcut for registration (pairing)

The registration (see page 35) can also be performed by the simple operation below.

- Make sure the watch is sufficiently charged before registration. (See pages 16 and 17.)

<b>Registration [PR]</b>	When the function hand on the upper right sub dial indicates “OFF”, <b>press and hold the upper right button B for seven seconds or more.</b>
--------------------------	---

- You can operate the buttons while the mode is set to [TME], [L-TM], [PR] or [CT], and the second hand indicates the second.
- If the second hand indicates “CALL”, “MAIL”, “LL”, or “ACT”, press and hold the lower right button A or upper right button B for two seconds to cancel the indication.

## Bluetooth 4.0 wireless technology

Bluetooth is a type of wireless communication technology used over distances of about 5 m (16-1/2 feet) to 10 m (33 feet) from handheld information products such as smartphones, head sets and game gadgets.

- This watch supports the Bluetooth 4.0 utilizing the electricity saving technology, Bluetooth 4.0 (Bluetooth Low Energy).
- The communication distance using Bluetooth may become smaller when obstacles such as walls exist. It may be particularly affected by the human body such as your arms.

The Bluetooth communication technology of this watch may not be usable depending on the law of the country. For a list of countries where it can be used, visit the following web page. If using this watch in a country other than those listed, you may be punished by the law of the country. Please confirm before use.

Citizen Watch global site: “<http://www.citizenwatch-global.com/>” → “Service & Support” → “W760” in “User’s Site”

Continued on the next page

Within the frequency band (2.4 GHz) used by this watch, local area wireless stations (wireless stations requiring a license) for identifying the mobile objects used on the production lines of factories, etc. in addition to industrial, scientific and medical applications such as microwaves, specific low electric power wireless stations (wireless stations not requiring a license), and amateur radio stations (wireless stations requiring a license) are operated.

- Please make sure that neither local area wireless stations for identifying mobile objects, specific low electric power wireless stations, nor amateur radio stations are being operated nearby before using this watch.
- Should any case of harmful radio wave interference from this watch to local area wireless station for identifying mobile objects occur, please stop using Bluetooth 4.0 immediately and consult the nearest Authorized Citizen Service Center for necessary steps to avoid interference.
- Should any trouble including other cases of harmful radio wave interference from this watch to specific low electric power wireless stations or amateur radio stations, please consult the nearest Authorized Citizen Service Center.

- The connectable distance for the Bluetooth 4.0 is approximately 10 m (33 feet) in an ideal location. Placing the transmitter and receiver behind reinforced concrete or metallic walls may block radio waves and disrupt sufficient communication. The communication distance may shorten depending on the environment where this watch is used.
- Placing this watch and the following electronic devices within close range may cause problems such as malfunction due to radio wave interference and production of noise.
  - Devices utilizing the 2.4 GHz frequency range including wireless LAN, microwaves, and digital cordless phones. Radio wave interference may cause cutting off of the sound.
  - Audio video equipment with an antenna input terminal including radios, TVs, video recorders, and satellite tuners. Noise may occur in the sound and image.
- Due to the use of radio waves, messages transmitted through this watch may be eavesdropped by third parties intentionally or accidentally. Do not use this watch for important communication or any communication involving human lives.

## Adjusting the time and calendar manually [TME]/[CAL]

### Adjusting the time — [TME]

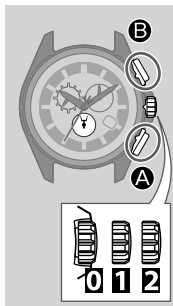

**1 Change the mode to [TME].** (See pages 18 and 19)

**2 Pull the crown out to position 2.**

The second hand rotates to indicate the current time.

**3 Press and release the lower right button A or upper right button B.**

The second hand moves to indicate the 0 seconds position.

## Adjusting the time and calendar manually [TME]/[CAL]

**4 Rotate the crown to adjust the time.**

- You can adjust the time in one minute increments.
- The hour and minute hands and 24-hour hand on the upper left sub dial move in conjunction with one another.
- When adjusting the time, be sure to pay particular attention to the 24-hour hand to ensure AM or PM time is set properly.
- If you spin the crown quickly a few times, the hand will move continuously. To stop the rapid movement, rotate the crown in either direction.

**5 Push the crown in to position 0 in accordance with a reliable time source to finish the procedure.**

This completes manual time adjustment.



**Adjusting the Calendar — [CAL]**

- The hour and minute hands and 24-hour hand on the upper left sub dial will indicate the time set in [TME] mode.
- While in [CAL] mode, notifications will be through watch vibration only. Visual notification by the second hand occurs only in [TME], [L-TM], [PR] or [CT] mode.

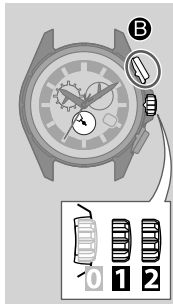

**1 Change the mode to [CAL].** (See pages 18 and 19)

**2 Pull the crown out to position 2.**

The second hand rotates to indicate the current month and leap year set in memory, while the function hand on the upper right sub dial rotates to indicate the current day of the week set in memory.

**3 Rotate the crown clockwise to adjust the month and leap year.**

- See pages 66 and 67 for instructions on how to read the month and leap year setting.
- Each time you rotate the crown, the second hand moves by one step.

**4 Press and release the upper right button B.**

The function hand on the upper right sub dial will move slightly to indicate that the date can be set.

**5 Rotate the crown to adjust the date.**

- Each time you rotate the crown fully clockwise, the function hand on the upper right sub dial will rotate five times and the date will advance by one day. When you rotate the crown fully counterclockwise, it will go back by one day.
- If you spin the crown quickly a few times, the date will move continuously. To stop the rapid movement, rotate the crown in either direction.

**6 Press and release the upper right button B.**

The function hand on the upper right sub dial will move slightly to indicate that the day of the week can be set.

**7 Rotate the crown to adjust the day of the week.**

- Each time you rotate the crown fully clockwise, the day of the week will advance by one day. When you rotate the crown fully counterclockwise, it will go back by one day.
- When pressing and releasing the upper right button B after setting the day of the week, you can return to setting the month and leap year.

## 8 Change the mode to [TME] (or [L-TM]) to finish the procedure. (See pages 18 and 19)

- The date will change at approximately 0:00 a.m. (midnight). This process takes approximately 5 seconds to complete.

### Month and year indications

The month and leap year are indicated by the position of the second hand when in [CAL] mode. When set correctly, the watch will be automatically adjusted for months shorter than 31 days as well as for leap years.

The month and leap year are indicated by the hour and minute indices. The years since the last leap year are indicated by the first three minute indices past each hour.

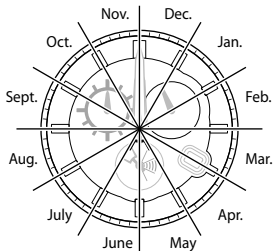

Each minute mark denotes the number of years since the last leap year.

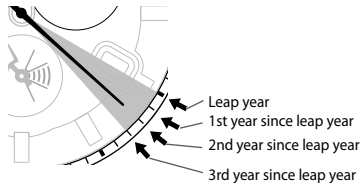

In the example above, the second hand indicates April and 2 years since the last leap year.

### Quick reference chart for number of years passed since leap year

Indication of the second hand	Leap Year/Years since leap year	Actual year
Hour marker	Leap year	2012, 2016, 2020
1st min. marker	1st year	2013, 2017, 2021
2nd min. marker	2nd year	2014, 2018, 2022
3rd min. marker	3rd year	2015, 2019, 2023

## Using local time

### [L-TM]

#### Indicating local time (secondary time)

The watch can indicate the time of another time zone (known as local time) using [L-TM] mode.

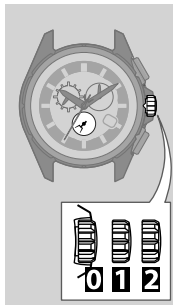

#### 1 Change the mode to [L-TM]. (See pages 18 and 19)

The currently set local time (secondary time) is displayed.

- The hour, minute, 24-hour, date and day of week are displayed.
  - If a local time (secondary time) has not been set, the time reflected will be that of the time set in [TME] mode.
- If you receive the time info while in [L-TM] mode, both the time set in [TME] and [L-TM] mode are adjusted.

#### Setting the local time

The setting range of the time difference from the time set in [TME] mode is  $\pm 27$  hours in 15-minute increments.

#### 1 Change the mode to [L-TM]. (See pages 18 and 19)

#### 2 Pull the crown out to position 2.

#### 3 Rotate the crown to set the time in 15-minute increments.

- When you rotate the crown quickly a few times, the hands will move continuously. To stop the rapid movement, rotate the crown in either direction.

#### 4 Push the crown in to position 0 to finish the procedure.

## Using the chronograph

[CHR]

The 60-minute chronograph can indicate a maximum of 59' 59".

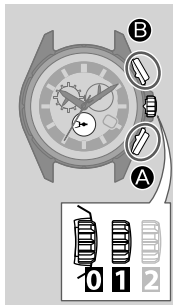

- While in [CHR] mode, notifications will be through watch vibration only. Visual notification by the second hand is disabled in this mode and will be made with another vibration when you change the mode to [TME], [L-TM], [PR] or [CT].

### 1 Change the mode to [CHR]. (See pages 18 and 19)

The second hand moves to indicate the 0 seconds position to enable you to measure time.

### 2 Use the chronograph.

- See page 71 for the method of measurement.

### 3 Change the mode to either [TME] (or [L-TM]) to exit chronograph [CHR] mode. (See pages 18 and 19)

## Using the chronograph [CHR]

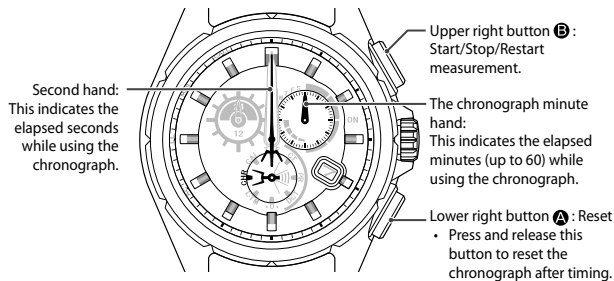

- After one hour of continuous chronograph operation, the chronograph automatically stops and is reset. Pulling out the crown will also stop and reset the chronograph.
- The time reflected by the hour and minute hands and 24-hour hand on the upper left sub dial will be that of the time set in [TME] or [L-TM] mode.

## Checking and correcting the reference position

If the time or date is not shown correctly even after proper reception of the time info, check whether the reference position is correct.

### What is the reference position?

The base position of all hands and date to properly indicate the various functions of this watch.

- **Position of the hour hand: 12:00**
- **Position of the minute hand: 12:00**
- **Position of the second hand: 12:00**
- **Position of the 24-hour hand on the upper left sub dial: 24:00**
- **Position of date: midway between 31 and 1**
- **Position of the function hand on the upper right sub dial: directed towards 6:00**
- If the hands and/or date do not reflect the correct reference position, the time, date, and other indications will not be displayed accurately, even if you synchronize the time with your iPhone.

Correct reference positions

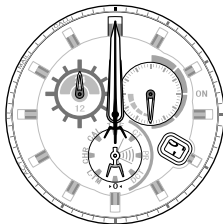

## Checking and correcting the reference position

### Checking the reference position

Check whether the reference position of each hand and indication is accurate.

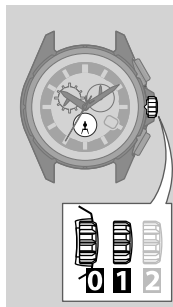

#### 1 Change the mode to . (See pages 18 and 19)

The hands and date will rotate to the current reference positions stored in memory.

#### 2 Check the current reference position.

By referring to the chart on page 72, ensure the reference position of each hand and the date are correct.

- If all reference positions are correct, go to step 3 below.
- If some reference positions are incorrect, go to page 74.

#### 3 Change the mode to either [TME] (or [L-TM]) to finish the procedure. (See pages 18 and 19)

**Correct the current reference position**

Correct each hand and indication to indicate the correct reference position.

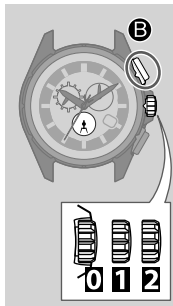
**1 Change the mode to [▶0◀].** (See pages 18 and 19)

Each hand and indication indicate the current reference position.

**2 Pull the crown out to position 2.**

This will enable you to correct the reference position.

**3 Press and release the upper right button B.**

Each time you press and release the upper right button B, the active hand will move slightly indicating that hand (or date) may be set. The order of movement is:

**Date/Function hand** → **Hour, minute and 24-hour hand** → **Second hand** → return to date/function hand

**4 Rotate the crown to correct the reference position of the active hand/indication.**

- When you rotate the crown quickly a few times, the hands and indications will move continuously. The second hand will move one full rotation, and the other hands and indications will move until you rotate the crown either clockwise or counterclockwise.

**5 Repeat steps 3 and 4 as required.****6 Push the crown in to position 0.****7 Change the mode to either [TME] (or [L-TM]) to finish the procedure.**  
(See pages 18 and 19)

## Troubleshooting

If you have a problem with your watch, check the table below.

Symptoms	Remedies	Page
----------	----------	------

### Connection with iPhone

Connection is unsuccessful • If you cannot solve your problem with the remedies shown on the right, consult the nearest Authorized Citizen Service Center.	Check the power reserve.	16 and 17
	Check the mode of the watch.	18 to 23
	Press and hold either the lower right button <b>A</b> or upper right button <b>B</b> for two seconds to cancel the notification indication.	33
	Push the crown in to position <b>0</b> .	–
	Avoid anything that will block out the radio wave or generate noise.	–
	Check the versions of your iPhone and iOS.	25
	Restart the dedicated app.	24

## Troubleshooting

Symptoms	Remedies	Page
Not notified within connectable distance	Check the connection status (“ON”, “OFF”).	32
	Check the power reserve.	16 and 17
	Ensure your iPhone is not being obscured such as by being in a pocket or purse.	–
	When in <b>[▶0◀]</b> , <b>[CHR]</b> or <b>[CAL]</b> mode, notification of Bluetooth 4.0 is through vibration only. The visual indication by the second hand is available only in <b>[TME]</b> , <b>[L-TM]</b> , <b>[PR]</b> or <b>[CT]</b> mode.	
	Turn “ON” of the functions on the app’s screen.	46 to 52
	Check the setting of mail accounts is “ON” on the app’s screen.	56
Registration is unsuccessful	Set the switch of “Waiting for Reconnection” to “OFF”.	35 to 40

Symptoms	Remedies	Page
<b>Connection with iPhone (continued)</b>		
Time info cannot be obtained automatically.	Check if your iPhone is in communication distance (5 m / 16-1/2 feet to 10 m / 33 feet) and avoid obstacles between the watch and the iPhone.	—
	Check the connection status (“ON”, “OFF”).	<b>32</b>
	Check if the watch is ready to receive the time info (the mode is set to [TME], [L-TM], [PR] or [CT] and the crown is in position 0).	<b>18 to 22</b>
	Check the status of your iPhone (charging or sleep mode).	—
iPhone does not sound using iPhone Search.	The switch of “Scan” on the app is “OFF” or the app is not active on the iPhone.	<b>51</b>
	Your iPhone is not in communication distance (5 m / 16-1/2 feet to 10 m / 33 feet).	<b>31</b>
	Earphones are plugged in.	<b>51</b>
	Your iPhone is not registered yet.	<b>35 to 40</b>

Symptoms	Remedies	Page
The second hand remains indicating “ACT” and does not move at all.	This may occur as a result of a pairing (registration) or connection failure. Pull the crown out to position 1 or 2, then push it in to position 0. If this does not work, leave the watch for about two or more minutes. If the second hand still does not move, consult the nearest Authorized Citizen Service Center.	—

**Movement of a hand seems strange**

The hands rotate rapidly soon after you expose the watch to light sufficient for charging (out of a case or pocket, from under a shirt sleeve, etc.).	The power save function is canceled. Wait until the current time is displayed.	<b>14 and 15</b>
The hands move in an unexpected direction.	Check the current mode.	<b>18 to 23</b>



Symptoms	Remedies	Page
The second hand does not move.	Check the current mode. The second hand does not move in some modes.	18 to 23
	Press and release either the lower right button <b>A</b> or upper right button <b>B</b> to cancel the notification indication.	—
The second hand moves once every two seconds.	This indicates low power. Fully charge the watch.	10 to 15

**The time and/or date is incorrect.**

The indication of the time and date is incorrect.	Change the mode to [TME].	18 to 20
	Adjust the time and calendar by synchronizing with the time/date info from your iPhone.	47
	Check the time shown on your iPhone.	—
	Adjust the time and calendar manually.	62 to 67
	Check and correct the reference position.	72 to 75

**Resetting the watch — All Reset**

When the watch hands move in an unusual manner (e.g. the hand does not stop moving, or the watch does not operate even though it has been recharged) due to strong shock or static, etc., we recommend resetting the watch (All Reset).

**Caution**

**When you reset the watch (All Reset), the settings of the watch will change as follows:**

- Calendar: January 1st (Sunday) (Leap year)
- Local time: ±0 hours

**Be sure to adjust the current reference position and time before use.**

- When using iPhone, iPhone is disconnected by performing All Reset. However, information about the registered iPhone will not be deleted

Be sure to perform the following operations after All Reset.

### 1. Correct the reference position.

After performing the All Reset feature, the watch is in the reference position mode. Refer to the reference position setting procedure outlined on page 74, starting from step 3.

### 2. Adjust the time and calendar (after correcting the reference position).

- When adjusting using iPhone: → Connect a iPhone (see page 44), then obtain the time info (see page 47).
- When adjusting manually: → See pages 62 to 67.

Make sure the watch is fully charged as outlined on pages 10 to 13 before proceeding.



### 1 Pull the crown out to position 1.

The second hand moves to indicate the 30 seconds position.

### 2 Rotate the crown to change the mode to [▶0◀].

All hands and identifications other than the second hand will indicate the current reference position stored in memory.

Do not operate the watch until all hands/indications stop moving.

### 3 Pull the crown out to position 2.

The second hand indicates the current reference position.

### 4 Press and release both the lower right button A and upper right button B simultaneously.

When you release the buttons, the watch will vibrate and all hands will move indicating All Reset is successful.

## Eco-Drive (solar powered) watch handling precautions

### <Always Make Sure to Recharge Frequently>

- Please note that if you wear long sleeves, the watch may stop as a result of being covered by your sleeve and blocked from the light.
- When you take off the watch, try to place it in as bright a location as possible. This will ensure optimal operation.

## Eco-Drive (solar-powered) watch handling precautions

### ⚠ CAUTION Recharging Precautions

- Do not charge the watch at a high temperature (about 60°C/140°F or higher) as doing so may cause the movement to malfunction.

#### Examples:

- Charging the watch too close to a light source which generates a large amount of heat such as an incandescent lamp or halogen lamp.
  - \* When charging under an incandescent lamp, be sure to leave 50 cm (19-11/16 inch) or more between the lamp and the watch to avoid exposing the watch to excessive heat.
- Charging the watch in a location where the temperature may become extremely high such as on the dashboard of a vehicle.

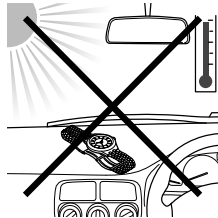

<Replacement of Rechargeable Cell>

- This watch utilizes a special rechargeable cell that does not require regular replacement. However power consumption may increase after using the watch for a number of years due to wear of internal components and deterioration of oils. This may cause stored power to be depleted at a faster rate. For optimal performance, we recommend having your watch inspected (chargeable to the owner) by an Authorized Service center to ensure operation is within factory specifications.

 **WARNING Handling of Rechargeable Cell**

- The rechargeable cell should never be removed from the watch.  
If for any reason it becomes necessary to remove the rechargeable cell from the watch, keep out of the reach of children to prevent accidental swallowing.  
If the rechargeable cell is accidentally swallowed, consult a doctor immediately.
- Do not dispose of the rechargeable cell with ordinary garbage. Please follow the instructions of your municipality regarding collection of batteries to prevent the risk of fire or environmental contamination.





 **WARNING Use Only the Specified Battery**

- Never use a battery other than the rechargeable cell specified for use in this watch. Although the watch structure is designed so that it will not operate when another type of battery is installed, if a silver battery or other type of battery is installed in the watch and the watch is recharged, there is the risk of overcharging which may cause the battery to rupture. This can cause damage to the watch and injury to the wearer.  
When replacing the rechargeable cell, always make sure to use the designated rechargeable cell.

## Water resistance

### **WARNING** Water Resistance

- Refer to the watch dial and the case back for the indication of the water resistance of your watch. The following chart provides examples of use for reference to ensure that your watch is used properly. (The unit "1bar" is roughly equal to 1 atmosphere.)
- WATER RESIST(ANT)  $\times\times$ bar may also be indicated as W.R. $\times\times$ bar.

Name	Indication	Specification	Water-related use				
	Dial or Case back						
Non-water resistant	—	Non-water resistant	<b>NO</b>	<b>NO</b>	<b>NO</b>	<b>NO</b>	<b>NO</b>
Everyday-use water resistant watch	WATER RESIST(ANT)	Water-resistant to 3 atmospheres	<b>OK</b>	<b>NO</b>	<b>NO</b>	<b>NO</b>	<b>NO</b>
Upgraded everyday use water-resistant watch	WATER RESIST(ANT) 5 bar	Water-resistant to 5 atmospheres	<b>OK</b>	<b>OK</b>	<b>NO</b>	<b>NO</b>	<b>NO</b>
	WATER RESIST(ANT) 10/20 bar	Water-resistant to 10 or 20 atmospheres	<b>OK</b>	<b>OK</b>	<b>OK</b>	<b>NO</b>	<b>NO</b>

## Water resistance

---

- Non-water resistant models are not designed to come into contact with any moisture. Take care not to expose a watch with this rating to any type of moisture.
- Water resistance for daily use (to 3 atmospheres) means the watch is water resistant for occasional accidental splashing.
- Upgraded water-resistance for daily use (to 5 atmospheres) means that the watch may be worn while swimming, but is not to worn while skin diving.
- Upgraded water-resistance for daily use (to 10/20 atmospheres) means that the watch may be worn while skin diving, but not while scuba or saturated diving using helium gas.

## Precautionary items and usage limitations

### **CAUTION To Avoid Injury**

- Be particularly careful when wearing your watch while holding a small child, to avoid injury.
- Be particularly careful when engaged in strenuous exercise or work, to avoid injury to yourself and others.
- Do NOT wear your watch while in a sauna or other location where your watch may become excessively hot, since there is the risk of burns.
- Be careful when putting on and taking off your watch, since there is a risk of damaging your fingernails, depending on the manner in which the band is fastened.
- Take off your watch before going to bed.

### **CAUTION Precautions**

- Always use the watch with the crown pushed in (normal position). If the crown is of the screw lock-type, make sure it is securely locked.
- Do NOT operate the crown or any push buttons when the watch is wet. Water may enter the watch causing damage to vital components.
- If water enters the watch or the watch fogs up and does not clear up even after a long time, consult your dealer or Customer Support Center for inspection and/or repair.

**⚠ CAUTION Precautions (continued)**

- Even if your watch has a high level of water resistance, please be careful of the following.
  - If your watch is immersed in sea water, rinse thoroughly with fresh water and wipe with a dry cloth.
  - Do not pour water from a tap directly onto your watch.
  - Take off your watch before taking a bath.
- If seawater enters the watch, place the watch in a box or plastic bag and immediately take it in for repair. Otherwise, pressure inside the watch will increase, and parts (crystal, crown, push button, etc.) may come off.

**⚠ CAUTION When Wearing Your Watch****<Band>**

- Leather, genuine skin and rubber (urethane) bands will deteriorate over time due to perspiration, body oils and dirt. Be sure to replace the band periodically.
- The durability of a leather band may be affected when wet (fading, peeling of adhesive), owing to the properties of the material. Moreover, wet leather may cause a rash.
- It is recommended to take off the watch if it gets wet, even if the watch itself is water-resistant.
- Do not wear the band too tightly. Try to leave enough space between the band and your skin to allow adequate ventilation.

- The rubber (urethane) band may be stained by dyes or soil present in or on clothing or other accessories. Since these stains may not be removable, caution is required when wearing your watch with items that tend to easily transfer color (articles of clothing, purses, etc.). In addition, the band may be deteriorated by solvents or moisture in the air. Replace with a new one when it has lost elasticity or become cracked.
- Please request adjustment or repair of the band in the following cases:
  - You notice an abnormality with the band due to corrosion.
  - The pin of the band is protruding.
- We do not recommend attempting to adjust the watch band yourself. Special expertise and experience is required for proper adjustment. If not adjusted correctly, the band may become detached leading to loss of your watch. (Some retailers may supply a band adjustment tool with your purchase).  
For band adjustment, we recommend you consult the retailer from where the watch was purchased or your nearest Authorized Citizen Service Center. Some repair shops may charge a nominal fee for adjustment if the watch was not purchased directly from them.

**<Temperature>**

- The watch may stop or the function of the watch may be impaired in extremely high or low temperature. Do not use the watch in places where the temperature is outside the operating temperature range as stated in the specifications on pages **98** and **99**.

### <Magnetism>

- Analog quartz watches are powered by a step motor that uses a magnet. Subjecting the watch to strong magnetism from the outside can cause the motor to operate improperly and prevent the watch from keeping time accurately.

Do not allow the watch to come into close proximity to magnetic health devices (magnetic necklaces, magnetic elastic bands, etc.) or the magnets used in the latches of refrigerator doors, clasps used in handbags, the speaker of a cell phone, electromagnetic cooking devices and so on.

### <Strong Shock>

- Avoid dropping the watch or subjecting it to other strong impact. It may cause malfunctions and/or performance deterioration as well as damage to the case and bracelet.

### <Static Electricity>

- The integrated circuits (IC) used in quartz watches are sensitive to static electricity. Please note the watch may operate erratically or not at all if exposed to intense static electricity.

### <Chemicals, Corrosive Gasses and Mercury>

- If paint thinner, benzene or other solvents or products containing these solvents (including gasoline, nail-polish remover, cresol, bathroom cleaners and adhesives, water repellent, etc.) are allowed to come into contact with the watch, they may discolor, dissolve or crack the materials. Be careful when handling these chemicals. Contact with mercury such as that used in thermometers may also cause discoloration of the band and case.

### <Protective Stickers>

- Be sure to remove any protective stickers that may be on your watch (case back, band, clasp, etc.). Otherwise, perspiration or moisture may enter the gaps between the protective stickers and the parts, which may result in a skin rash and/or corrosion of the metal parts.

### **CAUTION** Always Keep Your Watch Clean

- Rotate the crown while it is pressed in fully and press the buttons periodically so they do not become stuck due to accumulations of foreign matter.
- The case and band of the watch come into direct contact with the skin in the same manner as undergarments. Corrosion of the metal or unnoticed soiling such as that caused by perspiration and dirt can soil sleeves and other portions of clothing. Keep your watch clean at all times.
- The case and band of the watch come into direct contact with the skin. If you think there is something wrong, discontinue wearing the watch immediately and consult your physician. In the case of accumulation of sweat or dirt on a metal band or case, clean thoroughly using a brush and neutral detergent. In the case of a leather or rubber (urethane) band, wipe clean using a dry cloth.
- Leather bands may become discolored by perspiration or dirt. Always keep your leather band clean by wiping with a dry cloth.



## Precautionary items and usage limitations

---

### Caring for Your Watch

- Wipe any dirt or moisture such as perspiration from the case and crystal with a soft cloth.
- For a metallic, plastic or rubber (urethane) watchband, wash any dirt off with water. Remove the small amounts of dirt trapped between the crevices of the metallic band with a soft brush.
- For a leather band, wipe off dirt using a dry cloth.
- If you will not be using your watch for an extended period of time, carefully wipe off any perspiration, dirt or moisture and store in a proper location, avoiding locations subject to excessively high or low temperatures and high humidity.

#### <When Luminous Paint is used for your watch>

The paint on the dial and hands helps you with reading the time in a dark place. The luminous paint stores light (daylight or artificial light) and glows in a dark place.

It is free from any radioactive substance or any other material harmful to a human body or environment.

- The light emission gradually becomes weaker as time passes.
- The duration of the light (“glow”) will vary depending on the brightness, types of and distance from a light source, exposure time, and the amount of the paint.
- The paint may not glow and/or may dissipate quickly if exposure to light was not sufficient.

## Information

### About Bluetooth

Bluetooth® word mark and logos are registered trademarks owned by Bluetooth SIG, Inc.

Some countries may prohibit the usage of the Bluetooth.

## Specifications

<b>Model</b>	W760	<b>Type</b>	Analog solar-powered watch
<b>Timekeeping accuracy (without reception)</b>	Within $\pm 15$ seconds per month when worn at normal operation temperatures (between $+5^{\circ}\text{C}/41^{\circ}\text{F}$ and $+35^{\circ}\text{C}/95^{\circ}\text{F}$ )		
<b>Operating temperature range</b>	$-10^{\circ}\text{C}/-14^{\circ}\text{F}$ to $+60^{\circ}\text{C}/140^{\circ}\text{F}$		
<b>Display functions</b>	<ul style="list-style-type: none"> <li>• Time: Hours, minutes, seconds, 24-hour</li> <li>• Calendar: Date, day of the week</li> </ul>		
<b>Maximum run time from full charge</b>	<ul style="list-style-type: none"> <li>• Fully charged to fully discharged (without Bluetooth 4.0): Approximately 1 year (in normal operation) Approximately 1.5 years (with power save feature)</li> <li>• Power reserve upon insufficient charge warning function: Approximately 10 days</li> </ul>		
<b>Battery</b>	Rechargeable cell (lithium button cell), 1pc.		



<b>Additional functions</b>	<ul style="list-style-type: none"> <li>• Solar power function</li> <li>• Power reserve indication (in four levels)</li> <li>• Overcharging prevention function</li> <li>• Insufficient charge warning function (two-second interval movement)</li> <li>• Energy saving function (power save feature)</li> <li>• Indications relative to Bluetooth 4.0 Connection status indication (<b>ON/OFF</b>) Indication of ongoing communication processing (<b>ACT</b>) Notification indication (<b>CALL/MAIL/LL</b>)</li> <li>• Chronograph (up to 60 minutes in one second increments)</li> <li>• Local time</li> <li>• Perpetual calendar (until February 28th, 2100)</li> </ul>
-----------------------------	--

Specifications and contents of this booklet are subject to change without prior notice.